

# AC Disconnect with Integrated Surge Protection for Small Cell Radio Heads

**RSCAC-9550-P-240 • RSCAC-9550-PS-240-D • RSCAC-9550-PH-240**

The RSCAC-9550 series is an AC Disconnect, Load Center and Surge Protection Device that is Suitable for Use as Service Equipment (SUSE).

It is designed to provide robust overvoltage surge protection for the AC power circuits for today's small cell radio systems. It employs Strikesorb® 30-A-2CHV modules capable of withstanding direct surge currents up to 5kA (10/350µs) and induced surge currents up to 60kA (8/20µs).

The RSCAC-9550 series provides dual (Line 1 to Neutral) (Line 2 to Neutral) protection for twelve AC circuits.

## Strikesorb®



RSCAC-9550-P-240



RSCAC-9550-PS-240-D



RSCAC-9550-PH-240

UL 67

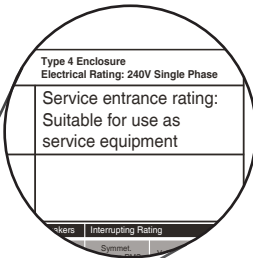

RSCAC-9550-P-240-D

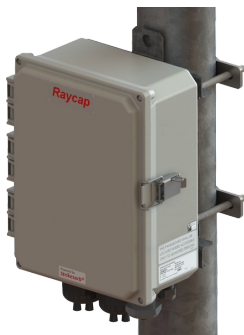

Bracket Included

## Features

- 60A main breaker Suitable for Use as Service Equipment (SUSE) without condition per UL and NEC
- 22kA Fault Current Rating (K<sub>AIC</sub>)
- Ships with six tandem pre-installed load breakers providing (12) 120VAC circuits which can be bridged to provide 240V
- 120/240VAC split phase configuration
- Employs the Strikesorb 30-A-2CHV Surge Protective Device (SPD)
  - The Strikesorb 30-A-2CHV is a Class I SPD, certified by VDE per the IEC 61643-11 standard as suitable for installation in areas where induced lightning exposure is expected
  - Strikesorb 30-A-2CHV is able to withstand direct surge currents up to 5kA (10/350µs) and induced surge currents of up to 60kA (8/20)
  - Provides low let through / clamping voltage - as it does not employ spark gaps or other switching elements
  - Strikesorb offers unique protection levels for wireless and small cell applications
- Comes with two compression fittings that can be replaced with 1.5" NPT conduit fittings
- Provides (Line 1 to Neutral, Line 2 to Neutral) protection for 120/240VAC split phase systems
- Compatible with duplex/double pole breakers
- Pole mount bracket facilitates mounting up to 4" diameter pole using existing clamps. Can also be banded to any diameter pole. Center mount holes (5/8") for center pole mount

## Benefits

- Offers unique maintenance free protection
- NEMA 4X or IP 68 & NEMA 6/6P rated enclosure, allowing for installation in harsh environments
- Lightweight design allows easy installation
- Up to twelve circuits for individual power control and over current protection of up to twelve small cell radio heads

Strikesorb is a registered trademark of Raycap  
 © 2024 Raycap All rights reserved.  
 G02-01-775 240515

**SPECIFICATIONS**

**AC Disconnect with Integrated Surge Protection for Small Cell Radio Heads**

**RSCAC-9550-P-240 • RSCAC-9550-PS-240-D • RSCAC-9550-PH-240**

**Strikesorb®**

**Electrical**

Model Number	RSCAC-9550-P-240	RSCAC-9550-PS-240-D	RSCAC-9550-PH-240
Main Disconnect	60A main breaker	60A main breaker	60A main breaker
Number of Circuits	Available up to 12	Available up to 12	Available up to 12
Breakers	Includes 6 tandem	Includes 6 tandem	Includes 6 tandem
Breaker Interrupt Rating (KAIC)	22kA	22kA	22kA
Means of External Disconnect	Internal	Hinged Cover	Internal
Surge Protection Device (SPD) Type to UL	Strikesorb 30-A-2CHV	Strikesorb 30-A-2CHV	Strikesorb 30-A-2CHV
Surge Protective Device (SPD) Type per UL 1449 5th Ed.	Recognized UL SPD	Recognized UL SPD	Recognized UL SPD
Surge Protection Device (SPD) Class to IEC 61643-11	Class I	Class I	Class I
Nominal Operating Voltage [U <sub>n</sub> ]	120V / 240V split phase	120V / 240V split phase	120V / 240V split phase
Nominal Discharge Current [I <sub>n</sub> ] per UL 1449 5th Ed.	20kA 8/20 μs	20kA 8/20 μs	20kA 8/20 μs
Maximum Discharge Current [I <sub>max</sub> ] per IEC 61643-11	60kA 8/20 μs	60kA 8/20 μs	60kA 8/20 μs
Impulse Discharge Current [I <sub>imp</sub> ] per IEC 61643-11	5kA 10/350 μs	5kA 10/350 μs	5kA 10/350 μs
Maximum Continuous Operating Voltage [U <sub>c</sub> ] (MCOV)	150V per line	150V per line	150V per line
Voltage Protection Level [U <sub>p</sub> ] per IEC 61643-11	700V	700V	700V
Suppression Technology	MOV	MOV	MOV
Protection Modes	L1 to Neutral, L2 to Neutral	L1 to Neutral, L2 to Neutral	L1 to Neutral, L2 to Neutral

**Mechanical**

Connection (Power)	Main Breaker #12 - #2Ø AWG (3.31 - 67.4mm <sup>2</sup> ) Branch Breaker #14 - #8 AWG (2.5 - 6mm <sup>2</sup> ) Ground and Neutral Busbars #14 - #2 AWG (2.08 - 33.6mm <sup>2</sup> )		
Environmental Ingress Protection (IP) Rating	NEMA 4X	NEMA 4X	IP68 & NEMA 6/6P
Operation Temperature (°C)	-40° C to +80° C	-40° C to +80° C	-40° C to +80° C
Storage Temperature (°C)	-70° C to +80° C	-70° C to +80° C	-70° C to +80° C
Enclosure Type (Outdoor)	Polycarbonate UL 94V-0 Rated	Polycarbonate UL 94V-0 Rated	Polycarbonate UL 94V-0 Rated
Enclosure Dimension (L x W x H)	12.39" x 9.38" x 5.65"	12.39" x 8.59" x 5.65"	12.39" x 8.59" x 5.65"
Enclosure	Hinged with Clasp	Hinged with Clasp	Hingeless with thumb screw
Weight	8 lbs [3.62kg]	8 lbs [3.62kg]	8 lbs [3.62kg]

**Standards Compliance & Certifications**

Strikesorb modules are compliant to the following Surge Protective Device (SPD) standards:

UL 1449 5th Edition: 2011, IEC 61643-11: 2011, EN 61643-11: 2012, IEEE C62.11: 2005, IEEE C62.41: 2002, IEEE C62.45: 2002, NEMA-LS-1

Certification UL, VDE, CE

Panel Board Certification UL 67 (suitable for use as service equipment)

**Additional Tandem Breakers Available**

Circuit Breaker 1P 15A/15A Tandem QO

Circuit Breaker 1P 20A/20A Tandem QO

Circuit Breaker 1P 30A/30A Tandem QO

**Product Diagram**

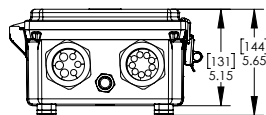
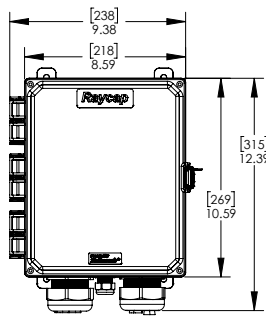
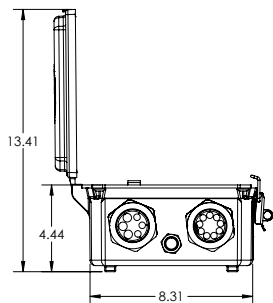
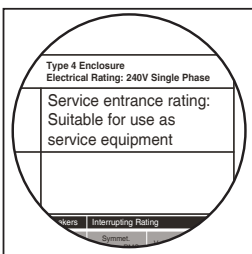

RSCAC-9550-P-240

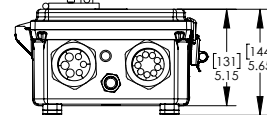
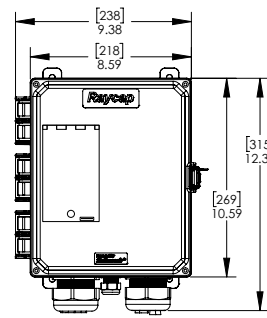

RSCAC-9550-PS-240-D

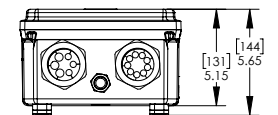
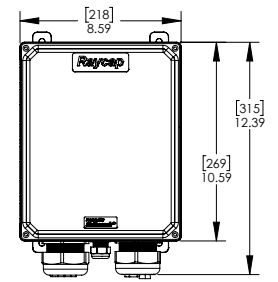

RSCAC-9550-PH-240

**Raycap**

www.raycap.com



AWG=American Wire Gauge

**AC Service Disconnect with Integrated Surge Protection for Micro Small Cell Radio Heads**

**RSCAC-9457-HP-120-D • RSCAC-9457-HP-120-ID**

The RSCAC-9457-HP-120-D is an AC Disconnect with integrated surge protection. It is designed to provide robust overvoltage surge protection for the AC power circuits for today's third and fourth generation distributed architecture radio systems. It employs Strikesorb® 30-A modules capable of withstanding induced surge currents of up to 60kA (8/20µs). The RSCAC-9457-HP-120-D provides dual (line to neutral) (neutral to ground) protection for four complete 120V AC circuits protecting four small cell radios.

Suitable for use as service equipment when a main breaker is used and when not more than six main disconnecting means are provided.



**Strikesorb®**



RSCAC-9457-HP-120-D

RSCAC-9457-HP-120-ID

**Features**

- 2 models: 60A External Disconnect / 60A Disconnect with internal switch
- (4) breakers total: (2) 16A breakers and (2) 10A din rail mounted branch breakers to supply 4-Micro Small Cell Radios
- Employs the Strikesorb 30-A Surge Protective Device (SPD)
  - The Strikesorb 30-A is a Class II SPD, certified by VDE per the IEC 61643-11 standard as suitable for installation in areas where induced lightning exposure is expected
  - Strikesorb 30-A is able to withstand induced surge currents of up to 60kA (8/20)
  - Provides low let through / clamping voltage - as it does not employ spark gaps or other switching elements
  - Strikesorb offers unique protection levels for wireless and small cell applications
- Comes with two compression fittings that can be replaced with 1.25" NPT conduit fittings
- Pole mount bracket facilitates mounting up to 4" diameter pole using existing clamps. Can also be banded to any diameter pole. Center mount holes (5/8") for center pole mount

**Benefits**

- Offers unique maintenance free protection
- Protects up to 4-Micro small cell radio heads
- Utilizes a IP68/NEMA 6/6P rated enclosure, allowing for indoor or outdoor installation
- Lightweight design allows easy installation
- Four Din Rail breakers for individual power control and over current protection of 4-Micro small cell radio heads

**Basic Applications**

- Telecommunications

**SPECIFICATIONS**

**AC Service Disconnect with Integrated Surge Protection for Micro Small Cell Radio Heads**

**Strikesorb®**

**RSCAC-9457-HP-120-D • RSCAC-9457-HP-120-ID**

**Electrical**

Model Number	RSCAC-9457-HP-120-D	RSCAC-9457-HP-120-ID
Breakers	(4)breakers total: (2)16A and (2)10A breakers	(4)breakers total: (2)16A and (2)10A breakers
Disconnect Type	Main Switch (must be installed behind main breaker)	Main Switch (must be installed behind main breaker)
Service Disconnect Switch	60A (external)	60A (internal)
Surge Protection Device (SPD) Type to UL	Strikesorb 30-A	Strikesorb 30-A
Number of Circuits Protected	4	4
Surge Protective Device (SPD) Type per UL 1449 5th Edition	Type 2 component assembly	Type 2 component assembly
Surge Protection Device (SPD) Class to IEC 61643-11	Class II	Class II
Nominal Operating Voltage [U <sub>n</sub> ]	120V	120V
Nominal Discharge Current [I <sub>n</sub> ] per UL 1449 5th Edition	20kA 8/20µs	20kA 8/20µs
Maximum Discharge Current [I <sub>max</sub> ] per IEC 61643-11	60kA 8/20µs	60kA 8/20µs
Maximum Continuous Operating Voltage [U <sub>c</sub> ] (MCOV)	150V	150V
Voltage Protection Level [U <sub>p</sub> ] per IEC 61643-11	700V	700V
Voltage Protection Rating (VPR)	20kA 8/20µs	20kA 8/20µs
Suppression Technology	MOV	MOV
Protection Modes (Dual Mode)	Line to neutral, neutral to ground	Line to neutral, neutral to ground
Maximum Fault Current	10kA	10kA

**Mechanical**

Connection Terminal (Power)	Compression Lug #6 - #14 AWG (13 - 2mm <sup>2</sup> ) Terminal Block #10-#26 AWG (6 - 0.14mm <sup>2</sup> )	
Environmental Ingress Protection (IP) Rating	NEMA 4X	IP68 & NEMA 6/6P (When lid screws are installed)
Operation Temperature (°C)	-40° C to +80° C	
Storage Temperature (°C)	-70° C to +80° C	
Enclosure Type (Outdoor)	Polycarbonate UL 94V-0 Rated	
Enclosure Dimension (L x W x H)	8.58" x 6.94" x 10.42" [218 x 176 x 265 mm]	8.58" x 5.06" x 10.42" [218 x 129 x 265 mm]
Weight	7.00 lbs [3.17kg]	6.85 lbs [3.10kg]

**Standards Compliance & Certifications**

Strikesorb modules are compliant to the following Surge Protective Device (SPD) standards:

UL 1449 5th Edition: 2011, IEC 61643-11: 2011, EN 61643-11: 2012, IEEE C62.11: 2005, IEEE C62.41: 2002, IEEE C62.45: 2002, NEMA-LS-1

Certification UL, VDE, CE

Panel Board Certification UL 67

**Product Diagram**

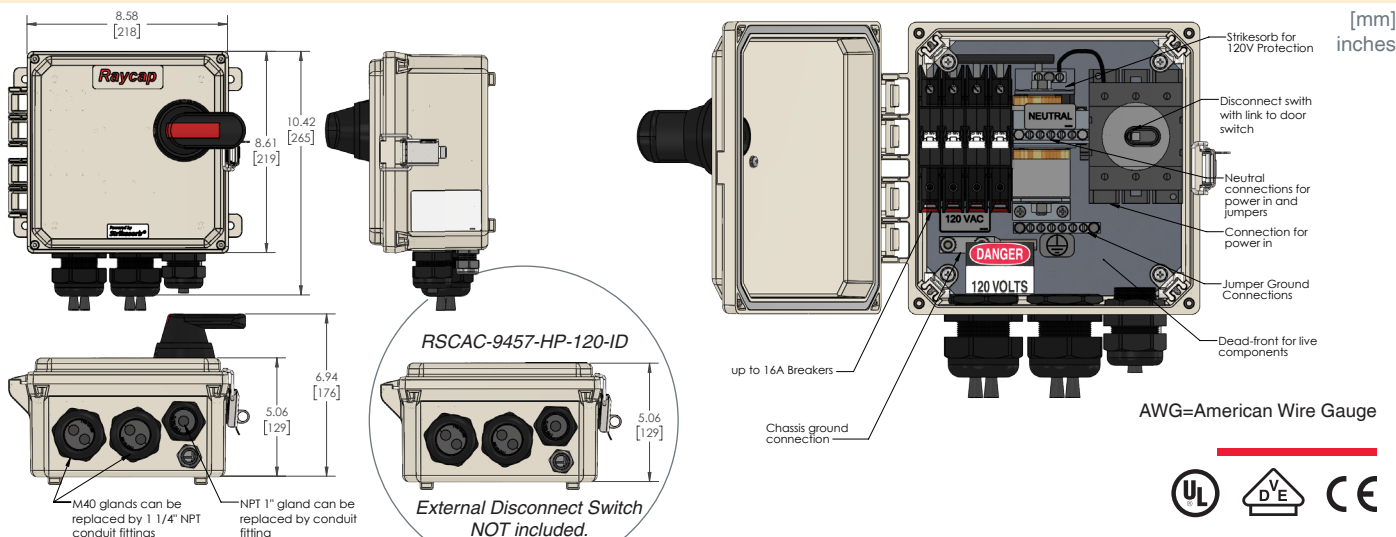

**Raycap**

www.raycap.com





# AC Service Disconnect with Integrated Surge Protection

## RSCAC-9457-HP-120-NH • RSCAC-6533-P-120-NH

### Strikesorb®

The RSCAC-9457-HP-120-NH and RSCAC-6533-P-120-NH are AC disconnect models with integrated surge protection. Designed to provide robust overvoltage surge protection for the AC power circuits used for both Micro and Pico radios. It employs Strikesorb® 30-A modules capable of withstanding induced surge currents of up to 60kA (8/20µs). The RSCAC-9457-HP-120-NH and RSCAC-6533-P-120-NH provide dual (line to neutral) (neutral to ground) protection for four complete 120V AC circuits protecting four small cell radios.

Suitable for use as service equipment when a main breaker is used and when not more than six main disconnecting means are provided.



RSCAC-9457-HP-120-NH

RSCAC-6533-P-120-NH

### Features

- 2 models: 60A Internal Disconnect / 30A Internal Disconnect
- (4) breakers total: (2) 16A breakers and (2) 10A din rail mounted branch breakers to supply 4-Micro Small Cell Radios for the 60A disconnect and (4) 7AMP for the 30A version.
- Employs the Strikesorb 30-A Surge Protective Device (SPD)
  - The Strikesorb 30-A is a Class II SPD, certified by VDE per the IEC 61643-11 standard as suitable for installation in areas where induced lightning exposure is expected
  - Strikesorb 30-A is able to withstand induced surge currents of up to 60kA (8/20)
  - Provides low let through / clamping voltage - as it does not employ spark gaps or other switching elements
  - Strikesorb offers unique protection levels for wireless and small cell applications
- Comes with two compression fittings that can be replaced with 1.25" NPT conduit fittings
- Pole mount bracket facilitates mounting up to 4" diameter pole using existing clamps. Can also be banded to any diameter pole. Center mount holes (5/8") for center pole mount

### Benefits

- Offers unique maintenance free protection
- Protects up to 4-Micro small cell radio heads
- Utilizes a IP68/NEMA 6/6P rated enclosure, allowing for indoor or outdoor installation
- Lightweight design allows easy installation
- Four Din Rail breakers for individual power control and over current protection of 4-Micro small cell radio heads

### Basic Applications

- Telecommunications

Strikesorb is a registered trademark of Raycap  
 © 2024 Raycap All rights reserved.  
 G02-01-331 240515

**SPECIFICATIONS**

**AC Service Disconnect with Integrated Surge Protection**  
**RSCAC-9457-HP-120-NH • RSCAC-6533-P-120-NH**

**Strikesorb®**

**Electrical**

Model Number	RSCAC-9457-HP-120-NH	RSCAC-6533-P-120-NH
Breakers	(4)breakers total: (2)16A and (2)10A breakers	(4)7A breakers
Disconnect Type	Main Switch (must be installed behind main breaker)	Main Switch (must be installed behind main breaker)
Service Disconnect Switch	60A (internal)	30A (internal)
Surge Protection Device (SPD) Type to UL	Strikesorb 30-A	Strikesorb 30-A
Number of Circuits Protected	4	4
Surge Protective Device (SPD) Type per UL 1449 5th Edition	Type 2 component assembly	Type 2 component assembly
Surge Protection Device (SPD) Class to IEC 61643-11	Class II	Class II
Nominal Operating Voltage [U <sub>n</sub> ]	120V	120V
Nominal Discharge Current [I <sub>n</sub> ] per UL 1449 5th Edition	20kA 8/20 μs	20kA 8/20 μs
Maximum Discharge Current [I <sub>max</sub> ] per IEC 61643-11	60kA 8/20 μs	60kA 8/20 μs
Maximum Continuous Operating Voltage [U <sub>c</sub> ] (MCOV)	150V	150V
Voltage Protection Level [U <sub>p</sub> ] per IEC 61643-11	700V	700V
Voltage Protection Rating (VPR)	20kA 8/20 μs	20kA 8/20 μs
Suppression Technology	MOV	MOV
Protection Modes (Dual Mode)	Line to neutral, neutral to ground	Line to neutral, neutral to ground
Maximum Fault Current	10kA	10kA

**Mechanical**

Connection Terminal (Power)	Compression Lug #6 - #14 AWG (13 - 2mm <sup>2</sup> ) Terminal Block #10-#26 AWG (6 - 0.14mm <sup>2</sup> )	
Environmental Ingress Protection (IP) Rating	IP68 & NEMA 6/6P (When lid screws are installed)	IP68 & NEMA 6/6P (When lid screws are installed)
Operation Temperature (°C)	-40° C to +80° C	
Storage Temperature (°C)	-70° C to +80° C	
Enclosure Type (Outdoor)	Polycarbonate UL 94V-0 Rated	
Enclosure Dimension (L x W x H)	8.58" x 5.06" x 10.42" [218 x 129 x 265 mm]	8.58" x 5.06" x 10.42" [218 x 129 x 265 mm]
Weight	6.7 lbs [3.04kg]	6.7 lbs [3.04kg]

**Standards Compliance & Certifications**

Strikesorb modules are compliant to the following Surge Protective Device (SPD) standards:

UL 1449 5th Edition: 2011, IEC 61643-11: 2011, EN 61643-11: 2012, IEEE C62.11: 2005, IEEE C62.41: 2002, IEEE C62.45: 2002, NEMA-LS-1

Certification UL, VDE, CE

Panel Board Certification UL 67

**Product Diagram**

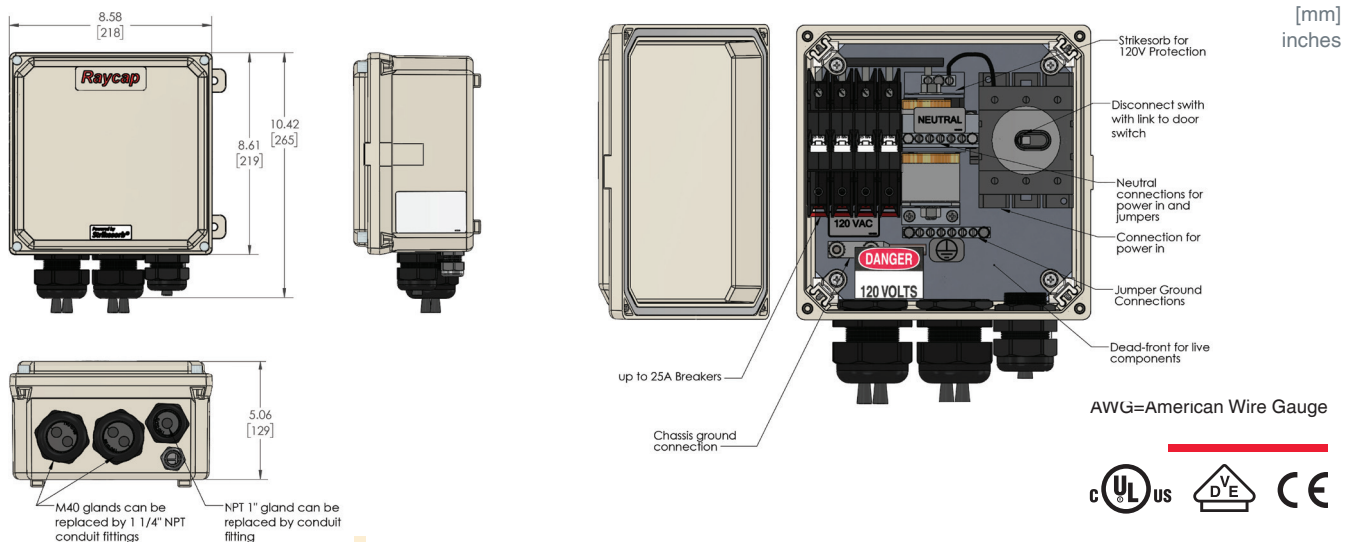

www.raycap.com

**AC Service Disconnect with Integrated Surge Protection for Pico Small Cell Radio Heads**

**RSCAC-6533-P-120-D • RSCAC-6533-P-120-ID**

**Strikesorb®**

The RSCAC-6533 series is an AC Disconnect load center and integrated surge protection. It is designed to provide robust overvoltage surge protection for the AC power circuits for today's third and fourth generation distributed architecture radio systems. It employs Strikesorb® 30-A modules capable of withstanding induced surge currents of up to 60kA (8/20µs). The RSCAC-6533-P-120-D provides dual (line to neutral) (neutral to ground) protection for four complete 120V AC circuits protecting four small cell radios.



RSCAC-6533-P-120-D

RSCAC-6533-P-120-ID

Suitable for use as service equipment when a main breaker is used and when not more than six main disconnecting means are provided.

**Features**

- 2 models: 30A External Disconnect / 30A Disconnect with internal switch
- Four 7amp din rail mounted branch breakers to supply 4-Pico Small Cell Radios
- Employs the Strikesorb 30-A Surge Protective Device (SPD)
  - The Strikesorb 30-A is a Class II SPD, certified by VDE per the IEC 61643-11 standard as suitable for installation in areas where induced lightning exposure is expected
  - Strikesorb 30-A is able to withstand induced surge currents of up to 60kA (8/20)
  - Provides low let through / clamping voltage - as it does not employ spark gaps or other switching elements
  - Strikesorb offers unique protection levels for wireless and small cell applications
- Comes with two compression fittings that can be replaced with 1.25" NPT conduit fittings and one compression fitting that can be replaced with 1" conduit fitting
- Pole mount bracket facilitates mounting up to 4" diameter pole using existing clamps. Can also be banded to any diameter pole. Center mount holes (5/8") for center pole mount

**Benefits**

- Offers unique maintenance free protection
- Protects up to 4-Pico small cell radio heads
- Utilizes a IP68/NEMA 6/6P rated enclosure, allowing for indoor or outdoor installation
- Lightweight design allows easy installation
- Four Din Rail breakers for individual power control and over current protection of 4-Pico small cell radio heads

**Basic Applications**

- Telecommunications



**SPECIFICATIONS**

**AC Service Disconnect with Integrated Surge Protection for Pico Small Cell Radio Heads**

**Strikesorb®**

**RSCAC-6533-P-120-D • RSCAC-6533-P-120-ID**

**Electrical**

Model Number	RSCAC-6533-P-120-D	RSCAC-6533-P-120-ID
Breakers	(4) 7 amp	(4) 7 amp
Disconnect Type	Main Switch (must be installed behind main breaker)	Main Switch (must be installed behind main breaker)
Service Disconnect Switch	30A (external)	30A (internal)
Surge Protection Device (SPD) Type to UL	Strikesorb 30-A	Strikesorb 30-A
Number of Circuits Protected	4	4
Surge Protective Device (SPD) Type per UL 1449 5th Edition	Type 2 component assembly	Type 2 component assembly
Surge Protection Device (SPD) Class to IEC 61643-11	Class II	Class II
Nominal Operating Voltage [U <sub>n</sub> ]	120V	120V
Nominal Discharge Current [I <sub>n</sub> ] per UL 1449 5th Edition	20kA 8/20 μs	20kA 8/20 μs
Maximum Discharge Current [I <sub>max</sub> ] per IEC 61643-11	60kA 8/20 μs	60kA 8/20 μs
Maximum Continuous Operating Voltage [U <sub>c</sub> ] (MCOV)	150V	150V
Voltage Protection Level [U <sub>p</sub> ] per IEC 61643-11	700V	700V
Voltage Protection Rating (VPR)	20kA 8/20 μs	20kA 8/20 μs
Suppression Technology	MOV	MOV
Protection Modes (Dual Mode)	Line to neutral, neutral to ground	Line to neutral, neutral to ground
Maximum Fault Current	10 kA	10 kA

**Mechanical**

Connection Terminal (Power)	Compression Lug #6 - #14 AWG (13 - 2mm <sup>2</sup> ) Terminal Block #10-#26 AWG (6 - 0.14mm <sup>2</sup> )	
Environmental Ingress Protection (IP) Rating	NEMA 4X	IP68 & NEMA 6/6P (When lid screws are installed)
Operation Temperature (°C)	-40° C to +80° C	
Storage Temperature (°C)	-70° C to +80° C	
Enclosure Type (Outdoor)	Polycarbonate UL 94V-0 Rated	
Enclosure Dimension (L x W x H)	8.58" x 6.94" x 10.42" [218 x 176 x 265 mm]	8.58" x 5.06" x 10.42" [218 x 129 x 265 mm]
Weight	7.00 lbs [3.17kg]	6.85 lbs [3.10kg]

**Standards Compliance & Certifications**

Strikesorb modules are compliant to the following Surge Protective Device (SPD) standards:

UL 1449 5th Edition: 2011, IEC 61643-11: 2011, EN 61643-11: 2012, IEEE C62.11: 2005, IEEE C62.41: 2002, IEEE C62.45: 2002, NEMA-LS-1

Certification UL, VDE, CE

Panel Board Certification UL 67

**Product Diagram**

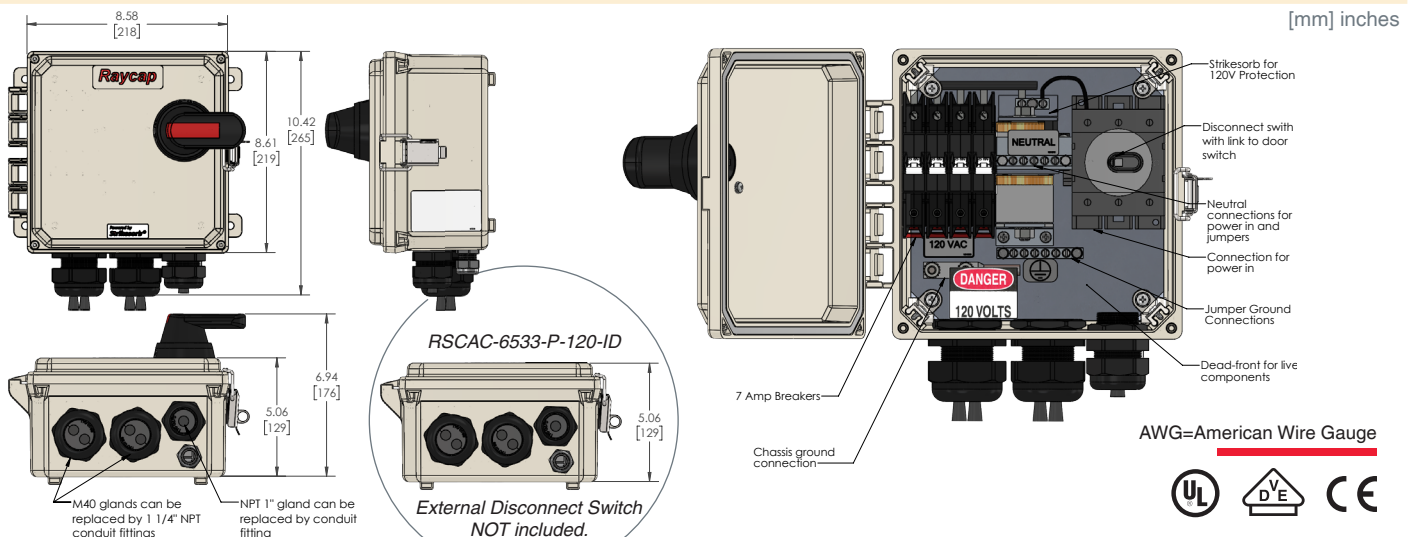

**Raycap**

www.raycap.com

G02-01-327 240515



## DATA SHEET

# AC Disconnect with Integrated Surge Protection for Small Cell Radio Heads

**RSCAC-1333-P-240 • RSCAC-1333-P-240-4 • RSCAC-1333-P-240-D  
RSCAC-1333-PS-240 • RSCAC-1333-PH-240**

The RSCAC-1333 series is an AC Disconnect, Load Center and Surge Protection Device that is Suitable for Use as Service Equipment (SUSE).

It is designed to provide robust overvoltage surge protection for the AC power circuits for today's small cell radio systems. It employs Strikesorb® 30-A-2CHV modules capable of withstanding direct surge currents up to 5kA (10/350µs) and induced surge currents up to 60kA (8/20µs). The RSCAC-1333 series provides dual (Line 1 to Neutral) (Line 2 to Neutral) protection for up to twelve AC circuits.

## Strikesorb®



RSCAC-1333-P-240  
RSCAC-1333-P-240-4



RSCAC-1333-P-240-D



RSCAC-1333-PS-240



RSCAC-1333-PH-240

## Features

- 60A main breaker Suitable for Use as Service Equipment (SUSE) without condition per UL and NEC
- 22kA Fault Current Rating (kAIC) (optional 42kA fault current rating)
- Ships with six tandem pre-installed load breakers providing (12) 120VAC circuits which can be bridged to provide 240V
- 120/240VAC split phase configuration
- Employs the Strikesorb 30-A-2CHV Surge Protective Device (SPD)
  - The Strikesorb 30-A-2CHV is a Class I SPD, certified by VDE per the IEC 61643-11 standard as suitable for installation in areas where induced lightning exposure is expected
  - Strikesorb 30-A-2CHV is able to withstand direct surge currents up to 5kA (10/350µs) and induced surge currents of up to 60kA (8/20)
- Provides low let through / clamping voltage - as it does not employ spark gaps or other switching elements
- Strikesorb offers unique protection levels for wireless and small cell applications
- Comes with two compression fittings that can be replaced with 1.5" NPT conduit fittings
- Provides (Line 1 to Neutral, Line 2 to Neutral) protection for 120/240VAC split phase systems
- Compatible with duplex/double pole breakers
- Pole mount bracket facilitates mounting up to 4" diameter pole using existing clamps. Can also be banded to any diameter pole. Center mount holes (5/8") for center pole mount

## Benefits

- Offers unique maintenance free protection
- NEMA 4X or IP 68 & NEMA 6/6P rated enclosure, allowing for installation in harsh environments
- Lightweight design allows easy installation
- Up to twelve circuits for individual power control and over current protection of up to twelve small cell radio heads

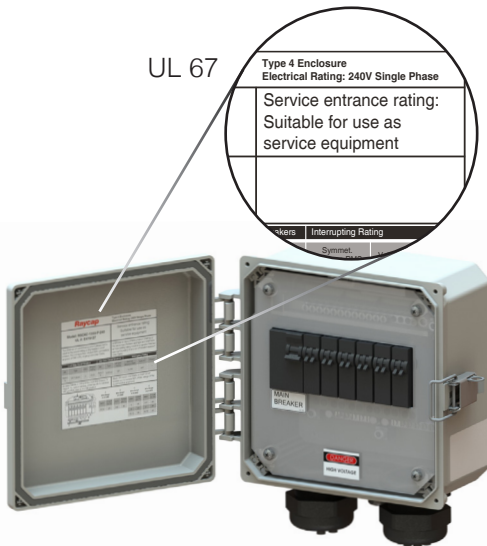

RSCAC-1333-P-240

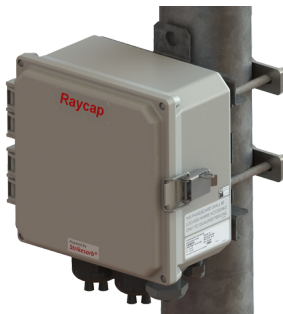

Bracket Included

# Raycap

[www.raycap.com](http://www.raycap.com)

Strikesorb is a registered trademark of Raycap  
© 2024 Raycap All rights reserved.  
G02-01-490 240515

**SPECIFICATIONS**

**AC Disconnect with Integrated Surge Protection  
for Small Cell Radio Heads**

**RSCAC-1333-P-240 • RSCAC-1333-P-240-4 • RSCAC-1333-P-240-D  
RSCAC-1333-PS-240 • RSCAC-1333-PH-240**

**Strikesorb®**

**Electrical**

Model Number	RSCAC-1333-P-240	RSCAC-1333-PS-240	RSCAC-1333-PH-240	RSCAC-1333-P-240-D	RSCAC-1333-P-240-4
Main Disconnect	60A main breaker	60A shunt trip main breaker	60A main breaker	60A main breaker	60A main breaker
Number of Circuits	Available up to 12	Available up to 10	Available up to 12	Available up to 12	Available up to 12
Breakers	Includes 6 tandem	Includes 5 tandem	Includes 6 tandem	Includes 6 tandem	Includes 6 tandem
Breaker Interrupt Rating (KAIC)	22kA	22kA	22kA	22kA	42kA
Means of External Disconnect	Internal	Shunt-Trip	Internal	Hinged Cover	Internal
Surge Protection Device (SPD) Type to UL	Strikesorb 30-A-2CHV	Strikesorb 30-A-2CHV	Strikesorb 30-A-2CHV	Strikesorb 30-A-2CHV	Strikesorb 30-A-2CHV
Surge Protective Device (SPD) Type per UL 1449 5th Ed.	Recognized UL SPD	Recognized UL SPD	Recognized UL SPD	Recognized UL SPD	Recognized UL SPD
Surge Protection Device (SPD) Class to IEC 61643-11	Class I	Class I	Class I	Class I	Class I
Nominal Operating Voltage [U <sub>n</sub> ]	120V / 240V split phase	120V / 240V split phase	120V / 240V split phase	120V / 240V split phase	120V / 240V split phase
Nominal Discharge Current [I <sub>n</sub> ] per UL 1449 5th Ed.	20 kA 8/20 μs	20 kA 8/20 μs	20 kA 8/20 μs	20 kA 8/20 μs	20 kA 8/20 μs
Maximum Discharge Current [I <sub>max</sub> ] per IEC 61643-11	60 kA 8/20 μs	60 kA 8/20 μs	60 kA 8/20 μs	60 kA 8/20 μs	60 kA 8/20 μs
Impulse Discharge Current [I <sub>imp</sub> ] per IEC 61643-11	5 kA 10/350 μs	5 kA 10/350 μs	5 kA 10/350 μs	5 kA 10/350 μs	5 kA 10/350 μs
Maximum Continuous Operating Voltage [U <sub>c</sub> ] (MCOV)	150V per line	150V per line	150V per line	150V per line	150V per line
Voltage Protection Level [U <sub>p</sub> ] per IEC 61643-11	700V	700V	700V	700V	700V
Suppression Technology	MOV	MOV	MOV	MOV	MOV
Protection Modes	L1 to Neutral, L2 to Neutral	L1 to Neutral, L2 to Neutral	L1 to Neutral, L2 to Neutral	L1 to Neutral, L2 to Neutral	L1 to Neutral, L2 to Neutral

**Mechanical**

Connection (Power)	Main Breaker #12 - #2Ø AWG (3.31 - 67.4mm <sup>2</sup> )    Branch Breaker #14 - #8 AWG (2.5 - 6mm <sup>2</sup> ) Ground and Neutral Busbars #14 - #2 AWG (2.08 - 33.6mm <sup>2</sup> )				
Environmental Ingress Protection (IP) Rating	NEMA 4X	NEMA 4X	IP68 & NEMA 6/6P		
Operation Temperature (°C)	-40° C to +80° C				
Storage Temperature (°C)	-70° C to +80° C				
Enclosure Type (Outdoor)	Polycarbonate UL 94V-0 Rated				
Enclosure Dimension (L x W x H)	10.43" x 9.38" x 5.06"	10.43" x 9.38" x 6.68"	10.43" x 8.59" x 5.06"		
Enclosure	Hinged with Clasp	Hinged with Clasp	Hingeless with thumb screw		
Weight	8 lbs [3.62kg]				

**Standards Compliance & Certifications**

*Strikesorb modules are compliant to the following Surge Protective Device (SPD) standards:*

UL 1449 5th Edition: 2011, IEC 61643-11: 2011, EN 61643-11: 2005, IEEE C62.11: 2005, IEEE C62.41: 2002, IEEE C62.45: 2002, NEMA-LS-1

Certification	UL, VDE, CE
Panel Board Certification	UL 67 (suitable for use as service equipment)



**Raycap**

[www.raycap.com](http://www.raycap.com)

**AC Disconnect with Integrated Surge Protection for Small Cell Radio Heads**  
**RSCAC-1333-P-240-D**

**Strikesorb®**

The RSCAC-1333 series is an AC Disconnect, Load Center and Surge Protection Device that is Suitable for Use as Service Equipment (SUSE).

It is designed to provide robust overvoltage surge protection for the AC power circuits for today's small cell radio systems. It employs Strikesorb® 30-A-2CHV modules capable of withstanding direct surge currents up to 5kA (10/350µs) and induced surge currents up to 60kA (8/20µs). The RSCAC-1333 series provides dual (Line 1 to Neutral) (Line 2 to Neutral) protection for up to twelve AC circuits.



**Features**

- 60A main breaker Suitable for Use as Service Equipment (SUSE) without condition per UL and NEC
- 22kA Fault Current Rating (kAIC)
- Ships with six tandem pre-installed load breakers providing (12) 120VAC circuits which can be bridged to provide 240V
- 120/240VAC split phase configuration
- Employs the Strikesorb 30-A-2CHV Surge Protective Device (SPD)
  - The Strikesorb 30-A-2CHV is a Class I SPD, certified by VDE per the IEC 61643-11 standard as suitable for installation in areas where induced lightning exposure is expected
  - Strikesorb 30-A-2CHV is able to withstand direct surge currents up to 5kA (10/350µs) and induced surge currents of up to 60kA (8/20)
- Provides low let through / clamping voltage - as it does not employ spark gaps or other switching elements
- Strikesorb offers unique protection levels for wireless and small cell applications
- Comes with two compression fittings that can be replaced with 1.5" NPT conduit fittings
- Provides (Line 1 to Neutral, Line 2 to Neutral) protection for 120/240VAC split phase systems
- Compatible with duplex/double pole breakers
- Pole mount bracket facilitates mounting up to 4" diameter pole using existing clamps. Can also be banded to any diameter pole. Center mount holes (5/8") for center pole mount

**Benefits**

- Offers unique maintenance free protection
- NEMA 4X or IP 68 & NEMA 6/6P rated enclosure, allowing for installation in harsh environments
- Lightweight design allows easy installation
- Up to twelve circuits for individual power control and over current protection of up to twelve small cell radio heads

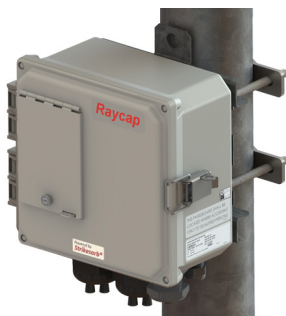
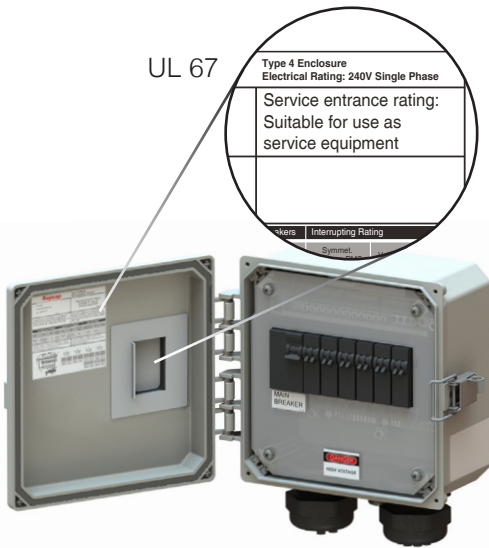

Bracket Included



**SPECIFICATIONS**

**AC Disconnect with Integrated Surge Protection  
for Small Cell Radio Heads  
RSCAC-1333-P-240-D**

**Strikesorb®**

**Electrical**

Model Number	RSCAC-1333-P-240-D
Main Disconnect	60A main breaker
Number of Circuits	Available up to 12
Breakers	Includes 6 tandem
Breaker Interrupt Rating (KAIC)	22kA
Means of External Disconnect	Hinged Cover
Surge Protection Device (SPD) Type to UL	Strikesorb 30-A-2CHV
Surge Protective Device (SPD) Type per UL 1449 5th Ed.	Recognized UL SPD
Surge Protection Device (SPD) Class to IEC 61643-11	Class I
Nominal Operating Voltage [U <sub>n</sub> ]	120V / 240V split phase
Nominal Discharge Current [I <sub>n</sub> ] per UL 1449 5th Ed.	20 kA 8/20 μs
Maximum Discharge Current [I <sub>max</sub> ] per IEC 61643-11	60 kA 8/20 μs
Impulse Discharge Current [I <sub>imp</sub> ] per IEC 61643-11	5 kA 10/350 μs
Maximum Continuous Operating Voltage [U <sub>c</sub> ] (MCOV)	150V per line
Voltage Protection Level [U <sub>p</sub> ] per IEC 61643-11	700V
Suppression Technology	MOV
Protection Modes	L1 to Neutral, L2 to Neutral

**Mechanical**

Connection (Power)	Main Breaker #12 - #2Ø AWG (3.31 - 67.4mm <sup>2</sup> ) Branch Breaker #14 - #8 AWG (2.5 - 6mm <sup>2</sup> ) Ground and Neutral Busbars #14 - #2 AWG (2.08 - 33.6mm <sup>2</sup> )
Environmental Ingress Protection (IP) Rating	NEMA 4X
Operation Temperature (°C)	-40° C to +80° C
Storage Temperature (°C)	-70° C to +80° C
Enclosure Type (Outdoor)	Polycarbonate UL 94V-0 Rated
Enclosure Dimension (L x W x H)	10.43" x 9.38" x 5.06"
Enclosure	Hinged with Clasp
Weight	8 lbs [3.62kg]

**Standards Compliance & Certifications**

<i>Strikesorb modules are compliant to the following Surge Protective Device (SPD) standards:</i> UL 1449 5th Edition: 2011, IEC 61643-11: 2011, EN 61643-11: 2012, IEEE C62.11: 2005, IEEE C62.41: 2002, IEEE C62.45: 2002, NEMA-LS-1	
Certification	UL, VDE, CE
Panel Board Certification	UL 67 (suitable for use as service equipment)

**Raycap**

[www.raycap.com](http://www.raycap.com)





## DATA SHEET

# AC Disconnect with Integrated Surge Protection for Small Cell Radio Heads **RSCAC1333-P-240-DL**

The RSCAC1333-P-240-DL is an AC Disconnect, Load Center and Surge Protection Device that is Suitable for Use as Service Equipment (SUSE).

It is designed to provide robust overvoltage surge protection for the AC power circuits for today's small cell radio systems. It employs Strikesorb® 30-A-2CHV modules capable of withstanding direct surge currents up to 5kA (10/350µs) and induced surge currents up to 60kA (8/20µs). The RSCAC1333-P-240-DL provides dual (Line 1 to Neutral) (Line 2 to Neutral) protection for up to twelve AC circuits.

## Strikesorb®

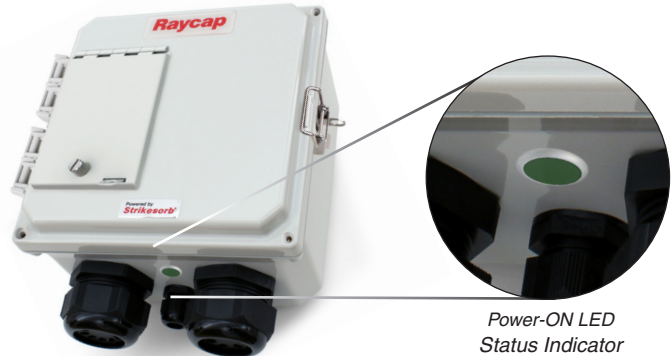

### Features

- 60A main breaker Suitable for Use as Service Equipment (SUSE) without condition per UL and NEC
- 22kA Fault Current Rating (kAIC)
- Ships with six tandem pre-installed load breakers providing (12) 120VAC circuits which can be bridged to provide 240V
- 120/240VAC split phase configuration
- Employs the Strikesorb 30-A-2CHV Surge Protective Device (SPD)
  - The Strikesorb 30-A-2CHV is a Class I SPD, certified by VDE per the IEC 61643-11 standard as suitable for installation in areas where induced lightning exposure is expected
  - Strikesorb 30-A-2CHV is able to withstand direct surge currents up to 5kA (10/350µs) and induced surge currents of up to 60kA (8/20)
  - Provides low let through / clamping voltage - as it does not employ spark gaps or other switching elements
  - Strikesorb offers unique protection levels for wireless and small cell applications
- Lockable front hatch access to the main breaker (Optional). Main power can be turned on and off without opening the main enclosure door. Lockout Tagout (LOTO) functionality.
- LED indicator for "Power On" status and the position of the Main Breaker Disconnect (Optional)
  - 1 breaker utilized for LED indicator
  - Maximum (11) 120VAC circuits, maximum (5) 240V feeds
- Comes with two compression fittings that can be replaced with 1.5" NPT conduit fittings
- Provides (Line 1 to Neutral, Line 2 to Neutral) protection for 120/240VAC split phase systems
- Compatible with duplex/double pole breakers
- Pole mount bracket facilitates mounting up to 4" diameter pole using existing clamps. Can also be banded to any diameter pole. Center mount holes (5/8") for center pole mount

### Benefits

- Offers unique maintenance free protection
- NEMA 4X or IP 66 rated enclosure, allowing for installation in harsh environments
- Lightweight design allows easy installation
- Up to eleven circuits for individual power control and over current protection of up to eleven small cell radio heads

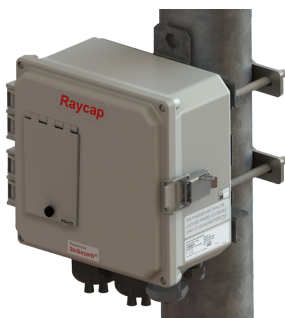
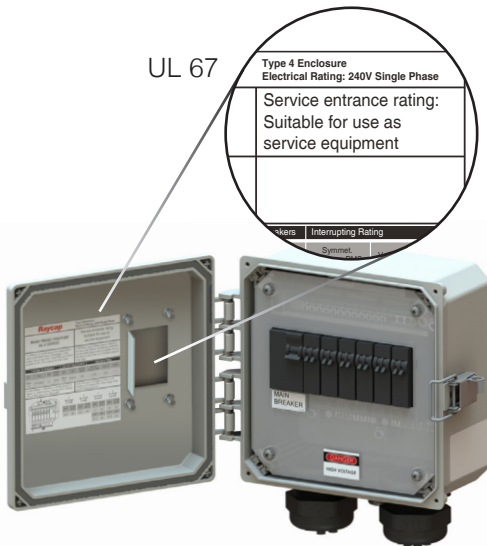

Bracket Included

Strikesorb is a registered trademark of Raycap  
© 2024 Raycap All rights reserved.  
G02-01-834 240515

# Raycap

www.raycap.com

**SPECIFICATIONS**

**AC Disconnect with Integrated Surge Protection  
for Small Cell Radio Heads**

**RSCAC1333-P-240-DL**

**Strikesorb®**

**Electrical**

Model Number	RSCAC1333-P-240-DL
Service Disconnect	60A main breaker (with external disconnect & Power-ON LED Status Indicator)
Number of Circuits	Available up to 12
Breakers	Includes 6 tandem
Breaker Interrupt Rating (KAIC)	22kA
Means of External Disconnect	Hinged Cover
Surge Protection Device (SPD) Type to UL	Strikesorb 30-A-2CHV
Surge Protective Device (SPD) Type per UL 1449 5th Ed.	Recognized UL SPD
Surge Protection Device (SPD) Class to IEC 61643-11	Class I
Nominal Operating Voltage [U <sub>n</sub> ]	120V / 240V split phase
Nominal Discharge Current [I <sub>n</sub> ] per UL 1449 5th Ed.	20kA 8/20µs
Maximum Discharge Current [I <sub>max</sub> ] per IEC 61643-11	60kA 8/20µs
Impulse Discharge Current [I <sub>imp</sub> ] per IEC 61643-11	5kA 10/350µs
Maximum Continuous Operating Voltage [U <sub>c</sub> ] (MCOV)	150V per line
Voltage Protection Level [U <sub>p</sub> ] per IEC 61643-11	700V
Suppression Technology	MOV
Protection Modes	L1 to Neutral, L2 to Neutral

**Mechanical**

Connection (Power)	Main Breaker #12 - #2Ø AWG (3.31 - 67.4mm <sup>2</sup> ) Branch Breaker #14 - #8 AWG (2.5 - 6mm <sup>2</sup> ) Ground and Neutral Busbars #14 - #2 AWG (2.08 - 33.6mm <sup>2</sup> )
Environmental Ingress Protection (IP) Rating	NEMA 4X or IP66
Operation Temperature (°C)	-40° C to +80° C
Storage Temperature (°C)	-70° C to +80° C
Enclosure Type (Outdoor)	Polycarbonate UL 94V-0 Rated
Enclosure Dimension (L x W x H)	10.43" x 9.38" x 6.25"
Enclosure	Hinged with Clasp
Weight	8 lbs [3.62kg]

**Standards Compliance & Certifications**

*Strikesorb modules are compliant to the following Surge Protective Device (SPD) standards:*  
 UL 1449 5th Edition: 2011, IEC 61643-11: 2011, EN 61643-11: 2012, IEEE C62.11: 2005, IEEE C62.41: 2002, IEEE C62.45: 2002, NEMA-LS-1

Certification	UL, VDE, CE
Panel Board Certification	UL 67 (suitable for use as service equipment)

**Product Diagram**

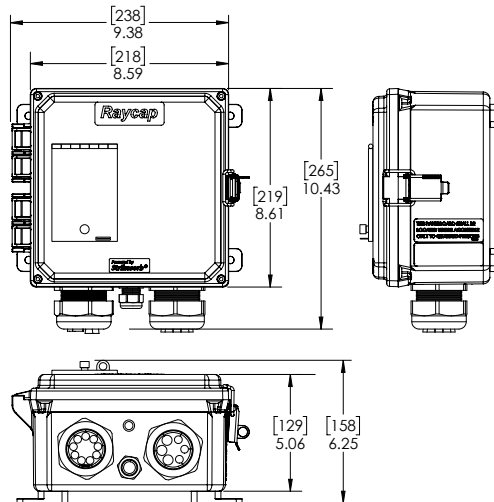

**Raycap**

[www.raycap.com](http://www.raycap.com)



# AC Disconnect with Integrated Surge Protection for Small Cell Radio Heads

**RSCAC-9556-P-240 • RSCAC-9556-P-240-D • RSCAC-9556-PH-240**

## Strikesorb®

The RSCAC-9556 series is an AC Disconnect, Load Center and Surge Protection Device that is Suitable for Use as Service Equipment (SUSE).

It is designed to provide robust overvoltage surge protection for the AC power circuits for today's small cell radio systems. It employs Strikesorb® 30-A-2CHV modules capable of withstanding direct surge currents up to 5kA (10/350µs) and induced surge currents up to 60kA (8/20µs).

The RSCAC-9556 series provides dual (Line 1 to Neutral) (Line 2 to Neutral) protection for twelve AC circuits.



RSCAC-9556-P-240

RSCAC-9556-P-240-D

RSCAC-9556-PH-240

### Features

- 100A main breaker Suitable for Use as Service Equipment (SUSE) without condition per UL and NEC
- 22kA Fault Current Rating (K<sub>AIC</sub>)
- Ships with six tandem pre-installed load breakers providing (12) 120VAC circuits which can be bridged to provide 240V
- 120/240VAC split phase configuration
- Employs the Strikesorb 30-A-2CHV Surge Protective Device (SPD)
  - The Strikesorb 30-A-2CHV is a Class I SPD, certified by VDE per the IEC 61643-11 standard as suitable for installation in areas where induced lightning exposure is expected
  - Strikesorb 30-A-2CHV is able to withstand direct surge currents up to 5kA (10/350µs) and induced surge currents of up to 60kA (8/20)
  - Provides low let through / clamping voltage - as it does not employ spark gaps or other switching elements
  - Strikesorb offers unique protection levels for wireless and small cell applications
- Comes with two compression fittings that can be replaced with 1.5" NPT conduit fittings
- Provides (Line 1 to Neutral, Line 2 to Neutral) protection for 120/240VAC split phase systems
- Compatible with duplex/double pole breakers
- Pole mount bracket facilitates mounting up to 4" diameter pole using existing clamps. Can also be banded to any diameter pole. Center mount holes (5/8") for center pole mount

UL 67

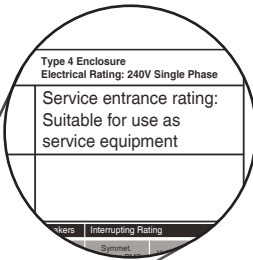

RSCAC-9556-P-240-D



Bracket Included

### Benefits

- Offers unique maintenance free protection
- NEMA 4X or IP 68 & NEMA 6/6P rated enclosure, allowing for installation in harsh environments
- Lightweight design allows easy installation
- Up to twelve circuits for individual power control and over current protection of up to twelve small cell radio heads

Strikesorb is a registered trademark of Raycap  
 © 2024 Raycap All rights reserved.  
 G02-01-806 240515

**SPECIFICATIONS**

**AC Disconnect with Integrated Surge Protection for Small Cell Radio Heads**

**RSCAC-9556-P-240 • RSCAC-9556-P-240-D • RSCAC-9556-PH-240**

**Strikesorb®**

**Electrical**

Model Number	RSCAC-9556-P-240	RSCAC-9556-P-240-D	RSCAC-9556-PH-240
Main Disconnect	100A main breaker	100A main breaker	100A main breaker
Number of Circuits	Available up to 12	Available up to 12	Available up to 12
Breakers	Includes 6 tandem	Includes 6 tandem	Includes 6 tandem
Breaker Interrupt Rating (KAIC)	22kA	22kA	22kA
Means of External Disconnect	Internal	Hinged Cover	Internal
Surge Protection Device (SPD) Type to UL	Strikesorb 30-A-2CHV	Strikesorb 30-A-2CHV	Strikesorb 30-A-2CHV
Surge Protective Device (SPD) Type per UL 1449 5th Ed.	Recognized UL SPD	Recognized UL SPD	Recognized UL SPD
Surge Protection Device (SPD) Class to IEC 61643-11	Class I	Class I	Class I
Nominal Operating Voltage [U <sub>n</sub> ]	120V / 240V split phase	120V / 240V split phase	120V / 240V split phase
Nominal Discharge Current [I <sub>n</sub> ] per UL 1449 5th Ed.	20kA 8/20 μs	20kA 8/20 μs	20kA 8/20 μs
Maximum Discharge Current [I <sub>max</sub> ] per IEC 61643-11	60kA 8/20 μs	60kA 8/20 μs	60kA 8/20 μs
Impulse Discharge Current [I <sub>imp</sub> ] per IEC 61643-11	5kA 10/350 μs	5kA 10/350 μs	5kA 10/350 μs
Maximum Continuous Operating Voltage [U <sub>c</sub> ] (MCOV)	150V per line	150V per line	150V per line
Voltage Protection Level [U <sub>p</sub> ] per IEC 61643-11	700V	700V	700V
Suppression Technology	MOV	MOV	MOV
Protection Modes	L1 to Neutral, L2 to Neutral	L1 to Neutral, L2 to Neutral	L1 to Neutral, L2 to Neutral

**Mechanical**

Connection (Power)	Main Breaker #12 - #2Ø AWG (3.31 - 67.4mm <sup>2</sup> ) Branch Breaker #14 - #8 AWG (2.5 - 6mm <sup>2</sup> ) Ground and Neutral Busbars #14 - #2 AWG (2.08 - 33.6mm <sup>2</sup> )		
Environmental Ingress Protection (IP) Rating	NEMA 4X	NEMA 4X	IP68 & NEMA 6/6P
Operation Temperature (°C)	-40° C to +80° C	-40° C to +80° C	-40° C to +80° C
Storage Temperature (°C)	-70° C to +80° C	-70° C to +80° C	-70° C to +80° C
Enclosure Type (Outdoor)	Polycarbonate UL 94V-0 Rated	Polycarbonate UL 94V-0 Rated	Polycarbonate UL 94V-0 Rated
Enclosure Dimension (L x W x H)	12.39" x 9.38" x 5.65"	12.39" x 8.59" x 5.65"	12.39" x 8.59" x 5.65"
Enclosure	Hinged with Clasp	Hinged with Clasp	Hingeless with thumb screw
Weight	8 lbs [3.62kg]	8 lbs [3.62kg]	8 lbs [3.62kg]

**Standards Compliance & Certifications**

Strikesorb modules are compliant to the following Surge Protective Device (SPD) standards:

UL 1449 5th Edition: 2011, IEC 61643-11: 2011, EN 61643-11: 2012, IEEE C62.11: 2005, IEEE C62.41: 2002, IEEE C62.45: 2002, NEMA-LS-1

Certification UL, VDE, CE

Panel Board Certification UL 67 (suitable for use as service equipment)

**Additional Tandem Breakers Available**

Circuit Breaker 1P 15A/15A Tandem QO

Circuit Breaker 1P 20A/20A Tandem QO

Circuit Breaker 1P 30A/30A Tandem QO

**Product Diagram**

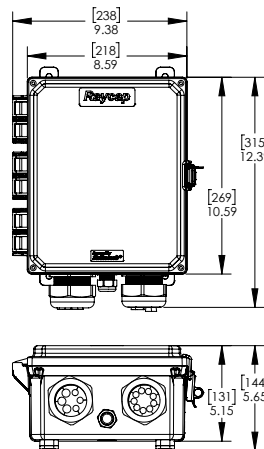
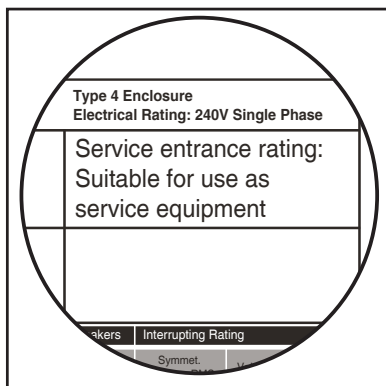

RSCAC-9556-P-240  
RSCAC-9556-P-240-D  
\*Hinged cover not shown

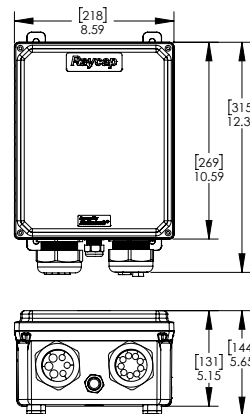

RSCAC-9556-PH-240



www.raycap.com

